

# 组装说明书 Assembly Manual

产品型号：西雅图B沙发（单人位）

成品图：  
Assembly View:

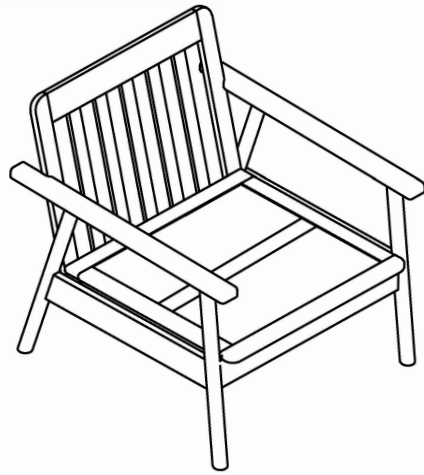

第一步：  
Step 1:

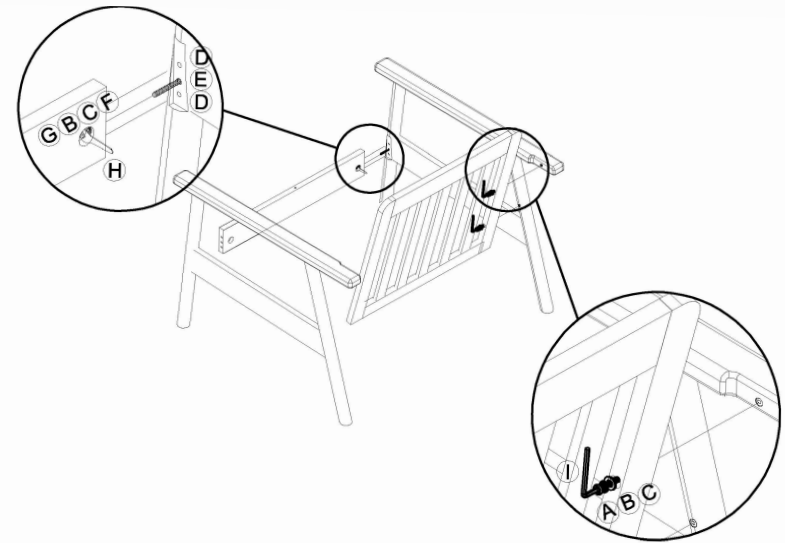



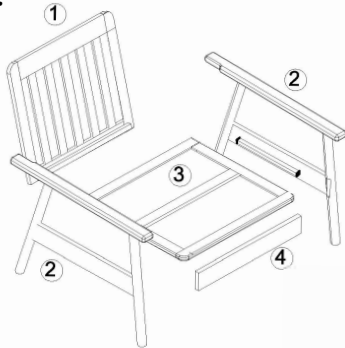



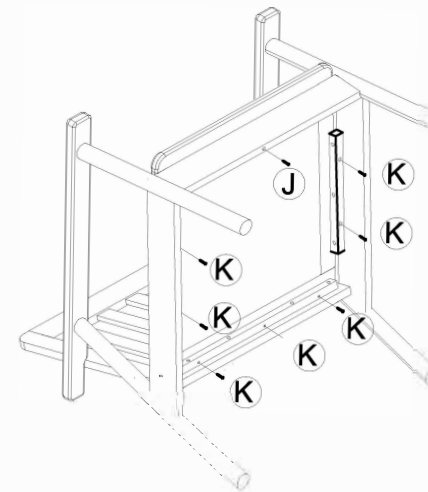



爆炸图：  
Exploded View:



第二步：  
Step 2:



五金清单：

<b>A</b>  M8 Hex Socket Screw x 4 内六角螺杆M8 x 4	<b>B</b>  M8 Spring Washers x 6 M8 弹垫 X 6	<b>C</b>  M8 Flat Washers x 6 M8 垫片 X 6	<b>D</b>  Full Thread Bolts M8 x 2 木棒 φ 10*30 X 2	<b>E</b>  Full Thread Bolts M8 x 2 全丝螺杆M8*80 X2	<b>F</b>  Half-Moon Washer x 2 半月牙 X2
<b>G</b>  Nut x 2 螺母 X2	<b>H</b>  Hex Key M5 x 1 扳手 X1	<b>I</b>  Hex Key M5 x 1 内六角 M5 X1	<b>J</b>  Self-Tapping Screws M4*50 x 1 自攻丝M4*50 X 1	<b>K</b>  Self-Tapping Screws M4*30 x 7 M4*30自攻丝 X 7	