

① Table top

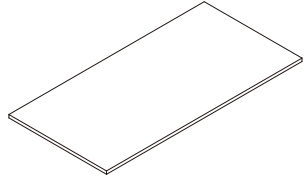

1 ×

② Crossbeam 1

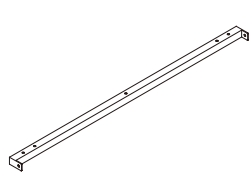

1 ×

③ Steel leg 1

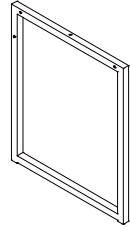

1 ×

④ Connecting rod

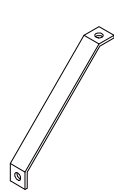

2 ×

⑤ Crossbeam 2

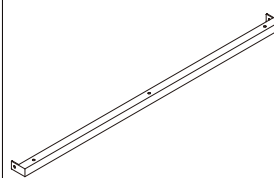

1 ×

⑥ Steel leg 2

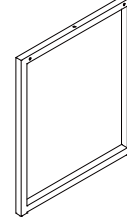

1 ×

E. Self-tapping screw

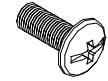

8 ×

F. Long self-tapping screw



8 ×

I. Screwdriver

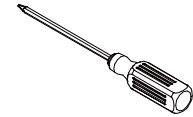

1 ×

STEP 1

Screw the beam to the panel. The screws will not be tightened first.

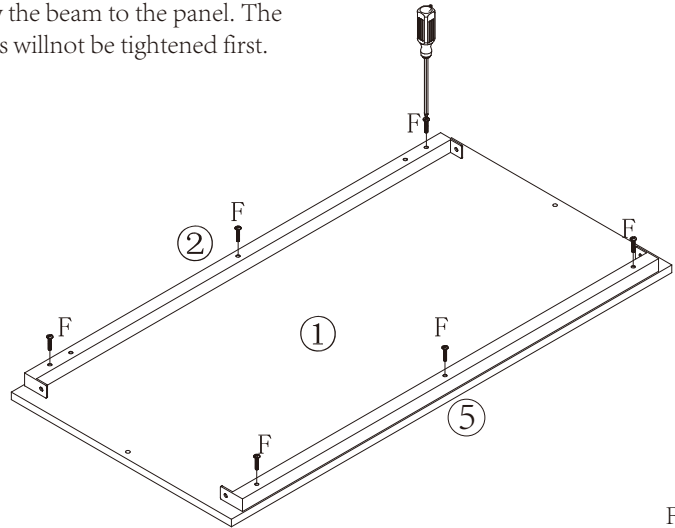

F × 6

STEP 2

Fix the two steel feet on the panel with screws and connect them with the crossbeams. Do not tighten the screws first.

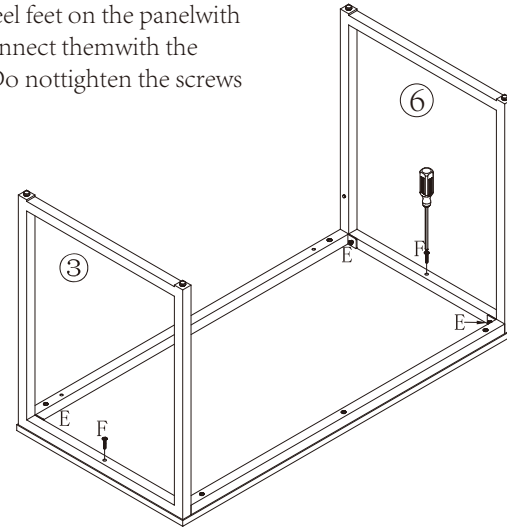

F × 2  
E × 4

STEP 3

Screw the connecting rod to the beam and steel feet, and then tighten all the screws firmly.

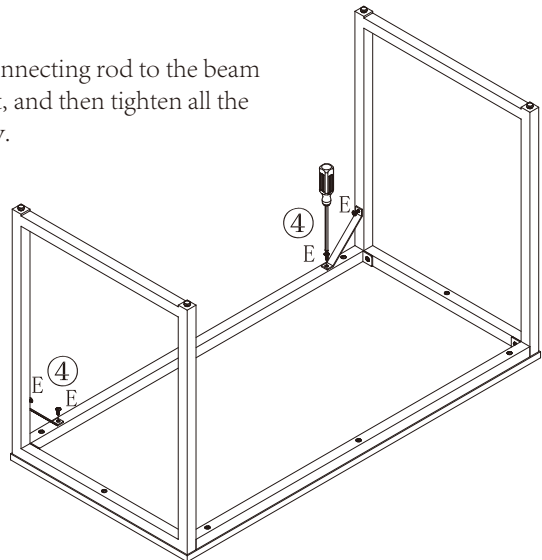

E × 4

STEP 4

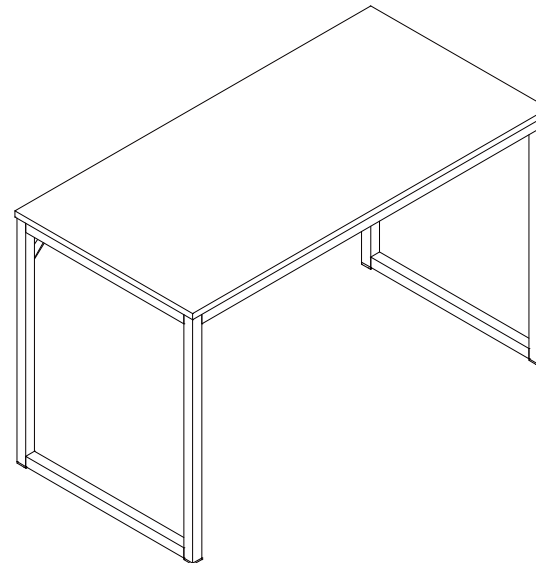

GF156-1206

1200\*600\* 740H

Note: Please install a blanket or this packing carton on the ground during installation, and then install it on blanket to avoid scratching the product parts!